

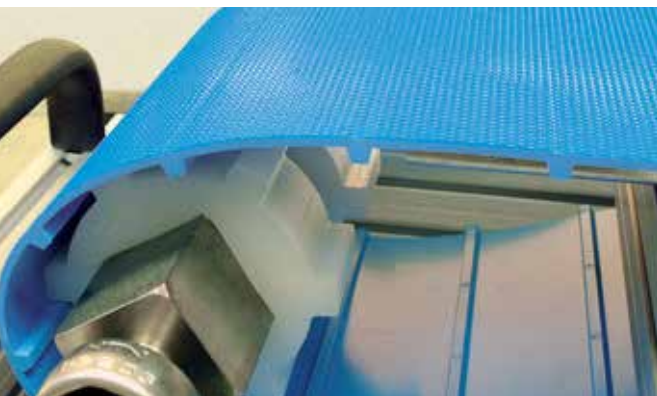

.....  
*Conveying Solutions*  
*Food Grade*  
*Positive Drive Line*

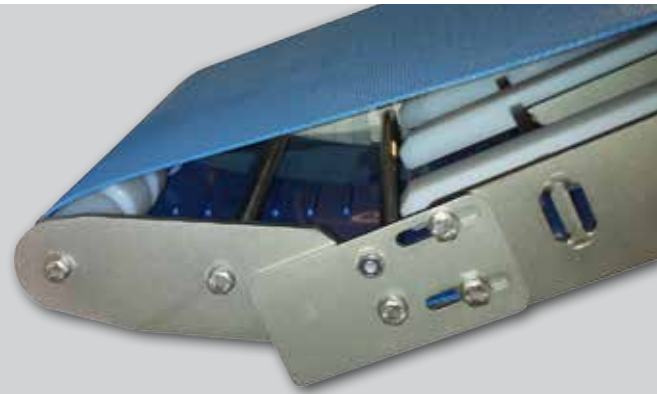
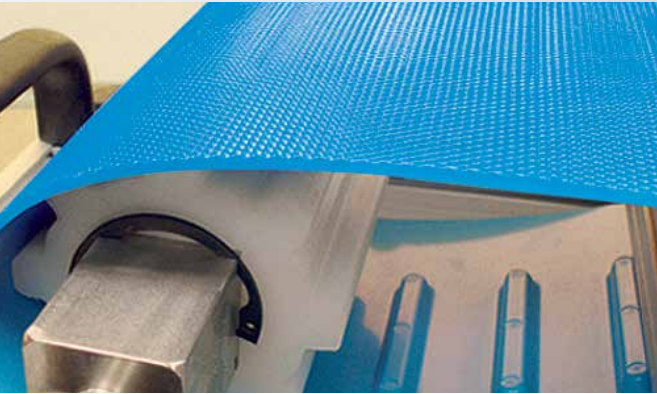

*The Next Step in Belting*

# SuperDrive™

The homogenous PositiveDrive™ belt, recognized worldwide as the best choice where hygiene and conveying efficiency are essential.

The unique design combines a tooth drive and off-tracking prevention with superior hygienic standards and productivity.

## SuperDrive™ components

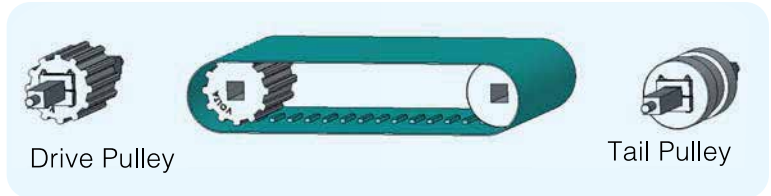

ITE  
Impression Top Embossed



ITO-50  
Impression Top Oval

Smooth Top SuperDrive™ Belts										
Product & Color	Shore Hardness	Temperature Range	Coefficient of Friction on UHMW*	Thickness	Minimum Pulley Diameter**		Maximum Pull Force***		Certifications	
					mm	mm	Inch	kg/cm		lbs/in
FHB-SD	55D	-20° C to 75° C -4° F to 170° F	0.20	3	126	4 <sup>31</sup> / <sub>32</sub>	7	39.2	FDA/ USDA/EU****	
FHW-SD				4	176	6 <sup>15</sup> / <sub>16</sub>	9	50.40		
				6*	300	11 <sup>13</sup> / <sub>16</sub>	14	78.40		
FHB-SD RAL5013	55D	-20° C to 75° C -4° F to 170° F	0.20	3	126	4 <sup>31</sup> / <sub>32</sub>	7	39.2	FDA/ USDA/EU****	
				4	176	6 <sup>15</sup> / <sub>16</sub>	9	50.40		
FMB-SD	53D	-20° C to 60° C -4° F to 140° F	0.28	3	80	3 <sup>1</sup> / <sub>4</sub>	6.25	35	FDA/ USDA/EU ****	
FMW-SD				4	120	4 <sup>3</sup> / <sub>4</sub>	8	44.80		
				6*	240	9 <sup>3</sup> / <sub>4</sub>	12.50	70		
FMB-SD-RAL5002	53D	-20° C to 60° C -4° F to 140° F	0.28	3	80	3 <sup>1</sup> / <sub>4</sub>	6.25	35	FDA/ USDA/EU ****	
Impression Top SuperDrive™ Belts										
FHB-SD-ITO50	55D	-20° C to 75° C -4° F to 170° F	0.20	3	126	4 <sup>31</sup> / <sub>32</sub>	7	39.2	FDA/ USDA/EU ****	
FHW-SD-ITO50				4	176	6 <sup>15</sup> / <sub>16</sub>	9	50.40		
FHB-SD-ITE	55D	-20° C to 75° C -4° F to 170° F	0.20	3	126	4 <sup>31</sup> / <sub>32</sub>	7	39.2	FDA/ USDA/EU ****	
FHW-SD-ITE				4	176	6 <sup>15</sup> / <sub>16</sub>	9	50.40		
FMB-SD-ITO50	53D	-20° C to 60° C -4° F to 140° F	0.28	3	80	3 <sup>1</sup> / <sub>4</sub>	6.25	35	FDA/ USDA/EU ****	
FMB-SD-ITE	53D	-20° C to 60° C -4° F to 140° F	0.20	3	80	3 <sup>1</sup> / <sub>4</sub>	6.25	35	FDA/ USDA/EU ****	
FMW-SD-ITE				3	80	3 <sup>1</sup> / <sub>4</sub>	6.25	35		
Metal Detectable (MD) SuperDrive™ Belt										
FMB-SD-MD	53D	-20° C to 60° C -4° F to 140° F	0.28	3	100	4	6	33.6	FDA/ USDA/EU	
Low Temperature (LT) SuperDrive™ Belts										
FMB-SD-LT	95A/46D	-35° C to 35° C -31° F to 95° F	0.30	3	80	3 <sup>1</sup> / <sub>4</sub>	3	16.80	FDA/ USDA/EU	
FMB-SD-ITO50-LT	95A/46D	-35° C to 35° C -31° F to 95° F	0.30	3	80	3 <sup>1</sup> / <sub>4</sub>	3	16.80	FDA/ USDA/EU ****	

Note: \* Available in Blue only.

\*\* Minimum Pulley Diameter – Normal Flex. Dimensions are relevant for an ambient temperature above 0° C / 32° F.

\*\*\* Maximum Pull Force – in kg/cm width & lb/in width.

\*\*\*\* Declaration of Conformity in compliance with EU Regulations No. : 10/2011, 1935/2004 and Directive 2002/72/EC. Compatible with HACCP principles.

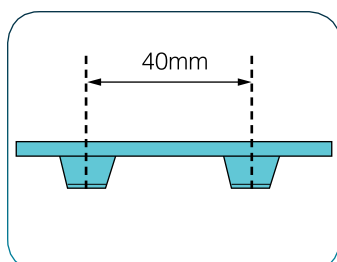

Pitch size for reference only

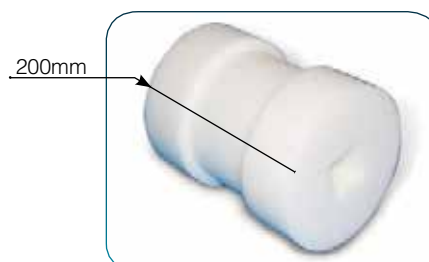

SuperDrive™ Tail Pulley

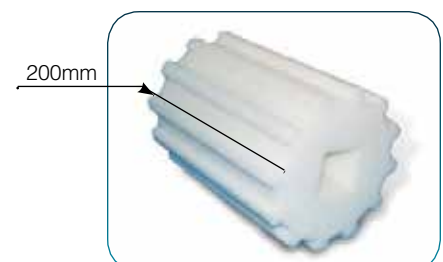

SuperDrive™ Drive Pulley

# Mini SuperDrive™

The only trackable Mini Positive Drive product.

The MiniSD™ design is similar to the world leader, Volta SuperDrive™; scaled down for a smaller minimum pulley.

Smooth Top Mini SuperDrive™ Belts										
Product & Color	Shore Hardness	Temperature Range	Coefficient of Friction on UHMW*	Thickness		Minimum Pulley Diameter**		Maximum Pull Force***		Certifications
				mm		mm	Inch	kg/cm	lbs/in	
FHB-MSD	55D	-20° C to 75° C -4° F to 170° F	0.20	2		80	3.15	4.5	25.2	FDA/ USDA/EU*
				2.5		100	3.93	5.6	31.36	
FMB-MSD	95A/46D	-20° C to 60° C -4° F to 140° F	0.28	2.5		48	1.89	3	16.8	FDA/ USDA/EU*

  

Impression Top Mini SuperDrive™ Belts										
Product & Color	Shore Hardness	Temperature Range	Coefficient of Friction on UHMW*	Thickness		Minimum Pulley Diameter**		Maximum Pull Force***		Certifications
				mm		mm	Inch	kg/cm	lbs/in	
FMB-MSD-ITO 50	95A/46D	-20° C to 60° C -4° F to 140° F	0.28	2.5		48	1.89	3	16.8	FDA/ USDA/EU*
FMB-MSD-MC	95A/46D	-20° C to 60° C -4° F to 140° F	0.28	2.5		80	3.15	3	16.8	FDA/ USDA/EU*

**Note:** \* Declaration of Conformity in compliance with EU Regulations No. : 10/2011, 1935/2004 and Directive 2002/72/EC. Compatible with HACCP principles.

\*\* Minimum Pulley Diameter – Normal Flex. Dimensions are relevant for an ambient temperature above 0° C / 32° F.

\*\*\* Maximum Pull Force – in kg/cm width & lb/in width.

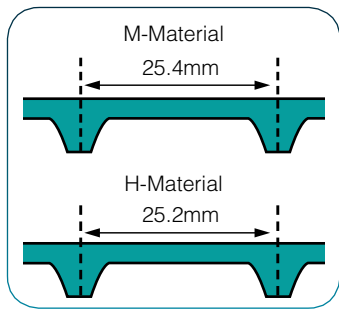

Pitch size for reference only

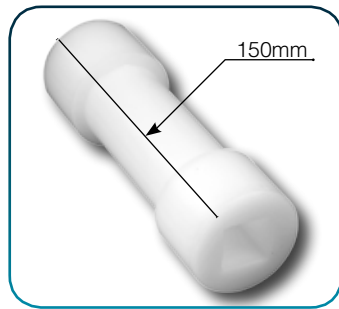

Tail Pulley

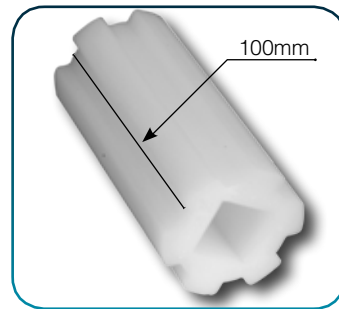

Drive Pulley

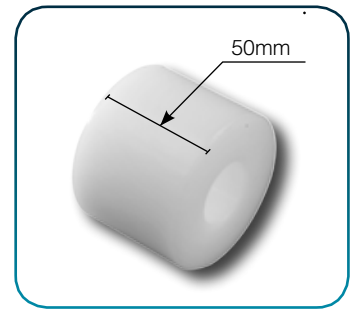

Support Pulley

# Mini DualDrive™

A scaled-down version of the original DualDrive™ tooth geometry.

FMB-2.5 MDD –Homogeneous 95A/46D Shore extrusion with high pull force for heavier loads.

Smooth Top Mini DualDrive™ Belts										
Product & Color	Shore Hardness	Temperature Range	Coefficient of Friction on UHMW*	Thickness		Minimum Pulley Diameter**		Maximum Pull Force***		Certifications
				mm		mm	Inch	kg/cm	lbs/in	
FMB-MDD	95A/46D	-20° C to 60° C -4° F to 140° F	0.28	2.5		48	1.89	4.5	25.2	FDA/ USDA/EU*

Standard belt width: 2032mm/80".

**Note:** \* Declaration of Conformity in compliance with EU Regulations No. : 10/2011, 1935/2004 and Directive 2002/72/EC. Compatible with HACCP principles.

\*\* Minimum Pulley Diameter – Normal Flex. Dimensions are relevant for an ambient temperature above 0° C / 32° F.

\*\*\* Maximum Pull Force – in kg/cm width & lb/in width.

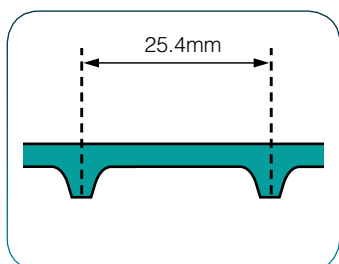

Pitch size for reference only



MDD Sprocket

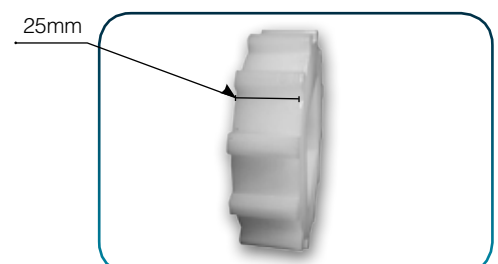

MDD Sprocket

# DualDrive™

- Minimal retrofitting required. DualDrive™ is suited to some 2" pitch modular belt sprockets but for both reliability and hygiene these should be replaced.
- DualDrive™ is a fully extruded positive drive belt with drive teeth running the full width of the belt at a 2" pitch.

## Mechanical Benefits:

- Replaces modular systems that require extensive cleaning and lengthy soaking and wear quickly at the joints.
- Greatly reduced noise levels in comparison with to modular belts.
- Integrated teeth for a positive drive with no slippage.
- No pretension of the belt is needed.
- Extruded in 30 or 60m (100 or 200ft) length and 1524mm (60") width.

## Material Features:

- Smooth or textured homogeneous surface.
- Special texture available for non-stick applications.
- No ply/fraying of fibers.
- Easy and effective cleaning.
- No cracks or crevices that can potentially harbor bacteria.

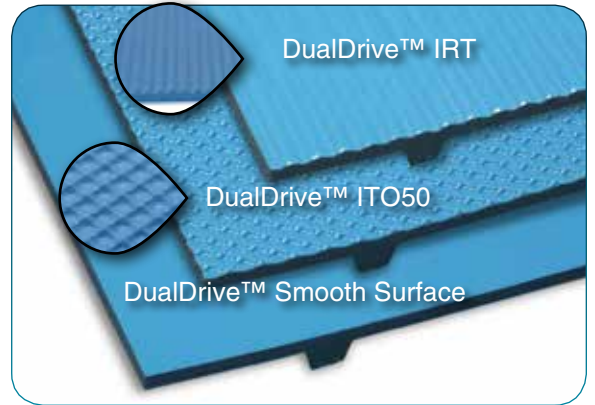
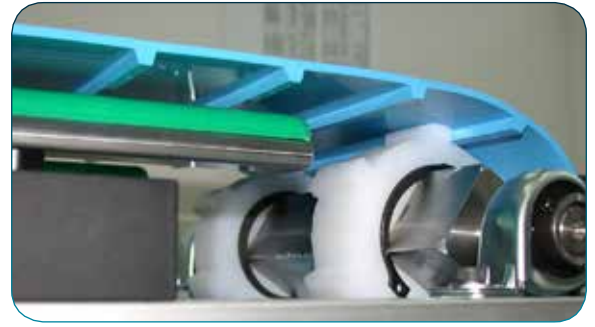

Smooth Top DualDrive™ Belts									
Product & Color	Shore Hardness	Temperature Range	Coefficient of Friction on UHMW*	Thickness	Minimum Pulley Diameter*		Maximum Pull Force**		Certifications
					mm	mm	Inch	kg/cm	
FHB-DD	55D	-20° C to 75° C -4° F to 170° F	0.20	3	100	4	7	39.2	FDA/ USDA/EU***
FHW-DD									
FMB-DD	53D	-20° C to 60° C -4° F to 140° F	0.28	3	80	3 1/4	6	33.6	FDA/ USDA/EU***
FMW-DD									
Impression Top DualDrive™ Belts									
FMB-DD-ITO50	53D	-20° C to 60° C -4° F to 140° F	0.28	3	80	3 1/4	6	33.6	FDA/ USDA/EU***
FMB-DD-IRT	53D	-20° C to 60° C -4° F to 140° F	0.28	4	100	4	6	33.6	FDA/ USDA/EU***
Metal Detectable (MD) DualDrive™ Belt									
FMB-DD-MD	53D	-20° C to 60° C -4° F to 140° F	0.28	3	100	4	6	33.6	FDA/ USDA/EU
Low Temperature (LT) DualDrive™ Belt									
FMB-DD-LT	95A/46D	-35° C to 35° C -31° F to 95° F	0.30	3	80	3 1/4	3	16.80	FDA/ USDA/EU***

**Note:** \* Minimum Pulley Diameter – Normal Flex. Dimensions are relevant for an ambient temperature above 0° C / 32° F.

\*\* Maximum Pull Force – in kg/cm width & lb/in width.

\*\*\* Declaration of Conformity in compliance with EU Regulations No. : 10/2011, 1935/2004 and Directive 2002/72/EC. Compatible with HACCP principles.

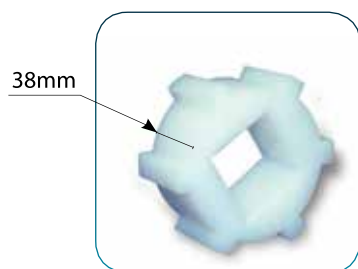

UHMW Sprockets

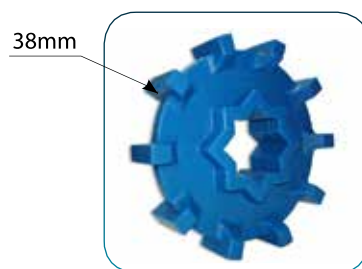

Molded Sprockets made of Acetal

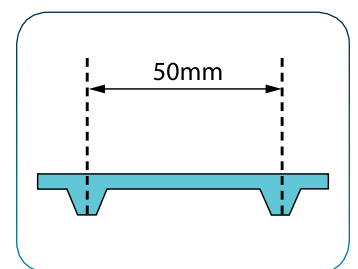

Pitch size for reference only



# DualDrive™ SP (Small Pulleys)

The DualDrive™ Small Pulley belt can be used for both low and high load applications.

There are 2 series of pulleys applicable;

- for use in high load (HL) applications;
- for use in low load (LL) applications.

One should ensure that the correct pulley type is chosen in relation to the required pull force. The use of incorrect pulleys can cause disengaging problems.

Smooth Top DualDrive™ Small Pulley (SP) Belt											
Product & Color	Shore Hardness	Temperature Range	Coefficient of Friction on UHMW*	Thickness	Minimum Pulley Diameter*		Maximum Pull Force**				Certifications
							Low Load		High Load		
							kg/cm	lbs/in	kg/cm	lbs/in	
FMB-DDSP	95A/46D	-30° C to 60° C -20° F to 140° F	0.28	2.5	50	2	1.5	8.4	4.5	25.2	FDA/ USDA/EU***
Impression Top DualDrive™ Small Pulley (SP) Belts											
FMB-DDSP-ITO50	95A/46D	-30° C to 60° C -20° F to 140° F	0.28	2.5	50	2	1.5	8.4	4.5	25.2	FDA/ USDA/EU***
FMB-DDSP-IRT	95A/46D	-30° C to 60° C -20° F to 140° F	0.28	3.2	50	2	1.5	8.4	4.5	25.2	FDA/ USDA/EU***
Low Temperature (LT) DualDrive™ Small Pulley (SP) Belt											
FMB-DDSP-LT	95A/46D	-35° C to 35° C -31° F to 95° F	0.28	2.5	50	2	1	5.6	2.7	15.1	FDA/ USDA/EU***

**Note:** \* Minimum Pulley Diameter – Normal Flex. Dimensions are relevant for ambient temperature above 0° C / 32° F.

\*\* Maximum Pull Force – in kg/cm width & lb/in width.

\*\*\* Declaration of Conformity in compliance with EU Regulations No. : 10/2011, 1935/2004 and Directive 2002/72/EC. Compatible with HACCP principles.

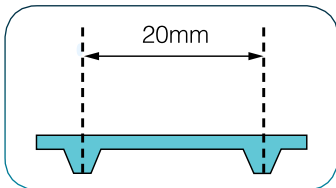

Pitch size for reference only

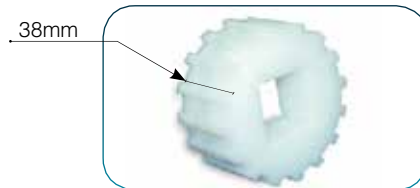

DualDrive™ Small Pulley for High Load

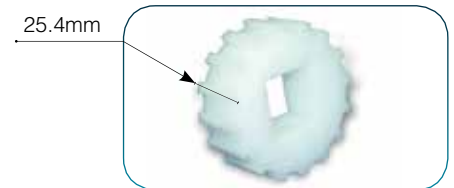

DualDrive™ Small Pulley for Low Load

## ➔ Volta Hinge Lace System

The Volta Lace is a device that allows a belt to be opened for cleaning or servicing of the conveyor. It is used in metal detection systems where a polyester hinge pin is used in place of steel. Volta lace is compatible with Volta 'M' material belts from 2.5 to 5 mm thickness but cannot be used with the MiniSD™ and MiniDD™ belts.

All Volta flat belt materials are easy to clean without removing from conveyor, and therefore lace is used only where absolutely necessary. The strength of the belt will be affected at the joint where lace is used.

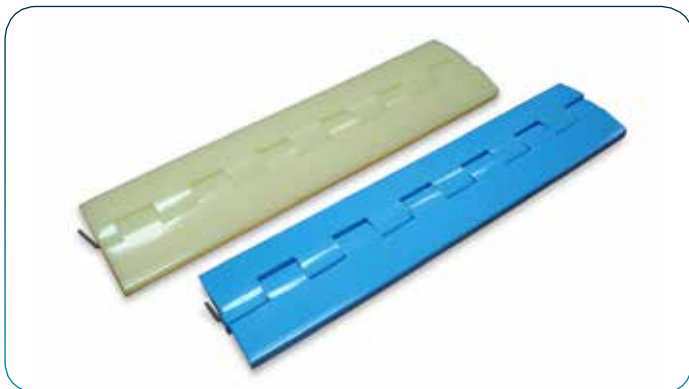

SD/DD Lace



DD SP Lace

*We are committed to providing a complete package focusing on servicing our customers all the way, up until the belts are safely installed and the conveyor is running smoothly.*

## ⤵ Fabrications on Positive Drive Belts

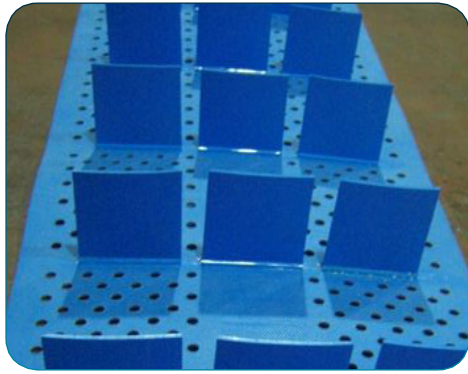

Perforated SuperDrive™ with Spaced Flights

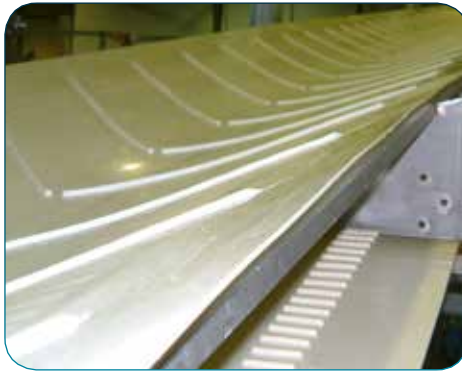

SuperDrive™ Trough Conveyor with Chevron Flights



DualDrive™ Small Pulley with Metal Spikes



Mini SuperDrive™ belt



SuperDrive™ with Welded Profiles



SuperDrive™ Z-elevator with Flights, Guides and Sidewalls

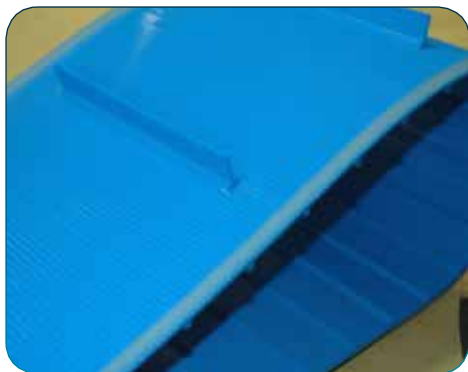

DualDrive™ with Impression Top IRT Flights & Guides



SuperDrive™ with Flights Working under Water



SuperDrive™ with Sidewalls and Special Flights



**Corporate Headquarters**  
Sales and Manufacturing  
sales@voltabelting.com

**USA**  
• Tel: +1 973 276 7905  
• Fax: +1 973 276 7908  
• Toll Free: 1-877-VOLTAUS

**EUROPE**  
• Tel: +31-546-580166  
• Fax: +31-546-579508

[www.voltabelting.com](http://www.voltabelting.com)

Volta Belting makes no warranty with respect to any of its products for a particular purpose.  
See **Volta** General Terms and Conditions.

Copyright© Volta Belting Technology Ltd.  
CAT501EN00- Ver.R June 2018