

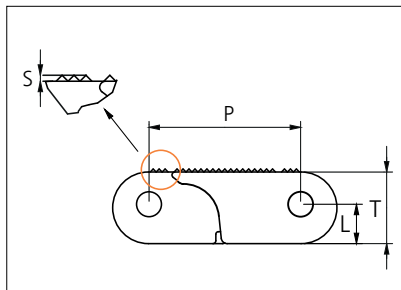

Plastic Modular Belt

Series **uni CSB** Type **Rough**



Straight running belt
 Nominal pitch: 50.8 mm (2.00 in)
 Surface type: Rough (R11)
 Surface opening: Closed
 Backflex radius: 100.0 mm (3.94 in)
 Pin diameter: 8.0 mm (0.31 in)

Belt material & color	POM NL K		POX-FR EG			mm	in		mm	in	
	Pin and lock material & color		PA6.6 N PP O	SS G PP O	PBT LG PP E	SS G PP E	P (Nominal)	50.8	2.00	T	24.0
						L	13.2	0.52	S	1.0	0.04

Non standard material and color: See uni Material and Color Overview.
 Safety edges with orange or yellow edge links mounted on alternating pitches along both belt edges are optional.
 Alternative pin and lock systems and materials: Contact Customer Service.

Belt width		Permissible tensile force (Belt/pin material)				***Belt weight (Belt/pin material)		Min No drive sprocket per shaft	Number of wear strips (min no)	
		POM NL/PA66 POX-FR/PBT		POM NL/SS POX-FR/SS		POM NL/PA66			**Carry (pcs)	**Return (pcs)
mm	in	N	lbf	N	lbf	Kg/m	lb/ft			
153	6.0	13725	3085	15250	3428	2.9	1.92	2	2	2
305	12.0	27450	6171	30500	6856	5.7	3.83	3	3	2
458	18.0	41177	9257	45753	10285	8.6	5.75	4	4	2
610	24.0	54905	12343	61005	13714	11.4	7.67	5	5	3
763	30.0	68632	15429	76258	17143	14.3	9.58	6	6	3
915	36.0	82360	18514	91511	20572	17.1	11.50	7	7	4
1068	42.0	96087	21600	106764	24000	20.0	13.42	8	8	4
1220	48.0	109815	24686	122016	27429	22.8	15.33	9	9	5
1373	54.0	123542	27772	137269	30858	25.7	17.25	10	10	5
1525	60.0	137269	30858	152522	34287	28.5	19.17	11	11	6
1678	66.1	150997	33944	167774	37716	31.4	21.08	12	12	6
1830	72.1	164724	37030	183027	41144	34.2	23.00	13	13	7

Additional standard belt widths are available in steps of 152.5 mm (6.00 in.) Additional non-standard belt widths are available in steps of 25.4 mm (1.00 in)

2898	114.1	260820	58632	289800	65147	54.2	36.42	20	20	10
------	-------	--------	-------	--------	-------	------	-------	----	----	----

Additional standard belt widths are available in steps of 152.5 mm (6.00 in.) Additional non-standard belt widths are available in steps of 25.4 mm (1.00 in)

3965	156.1	356850	80220	396500	89133	74.1	49.83	27	27	14
------	-------	--------	-------	--------	-------	------	-------	----	----	----

General belt tolerance is +0/-0.4% at 23°C/73°F and 50% RH. For exact belt width contact Customer Service. Non standard belt width on request.

Belt widths in POX FR is 1.0 % wider than the belt widths in the table above.

*Max. Load per Drive Sprocket. Belt material: NL 6000 N (1349 lbf). PP 4000 N (899 lbf). POX FR 6000 N (1349 lbf).

**Max. Spacing between wear strips. Carry: 152.0 mm (6.00 in); Return: 304.0 mm (12.00 in).

***The weight of the belt with SS pins is 6.7 kg/m² (0.42 lb/ft²) higher than with PA66 pins.

***The weight in POX FR is approximately 12% lower than the weight of NL.

= Single Link



STANDARD

STRAIGHT RUNNING

PITCH 50.8 MM/2.00 IN

Accessories

NON STANDARD – Rubber Top

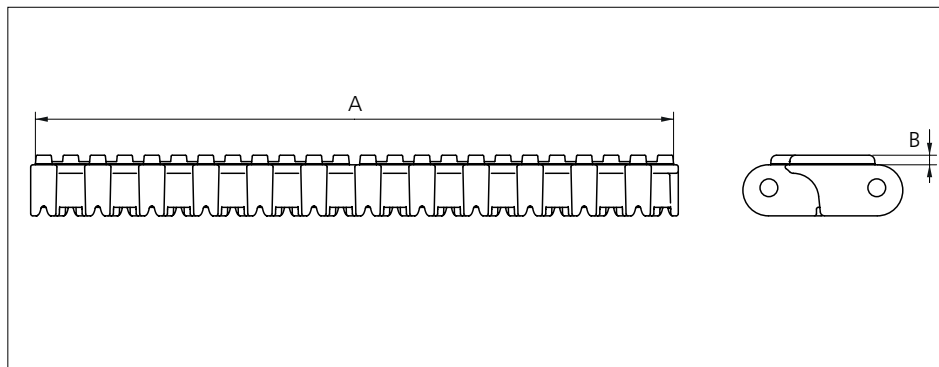

Type	Recommended belt material & color	Recommended rubber material & color	A		B		Link size	Width	
			mm	in	mm	in		mm	in
Flat Rib	PP DG	03 K	300.0	11.81	4.5	0.18	K1200	304.8	12.00

Backflex radius when flights are used: 200 mm (7.87 in).

Accessories

Top/Bottom Insert



+

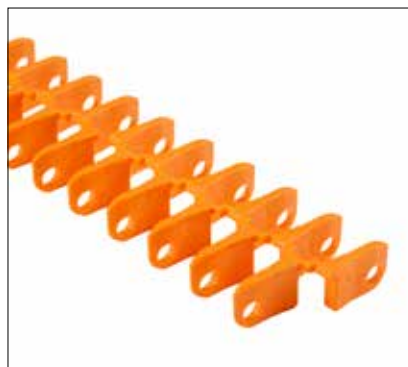

=

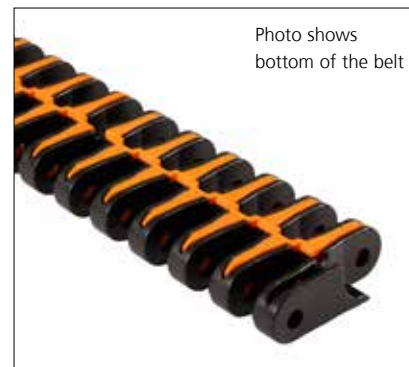

Type	Insert material & color	Weight	
		kg/m ²	lb/ft ²
Wheel Plate	POM-DK O POM-NL Y PEI G PA6 D	4.7	0.97

Contact area/wear surface of belt will increase from 24% to 47% by the use of inserts.

Accessories

Top/Bottom Insert

EC insert in uni CSB 8% Rough type can be build in to uni CSB Closed Rough to create an electrical conductive belt.



+



=



Type	Insert material & color	Weight	
		kg/m ²	lb/ft ²
Electrical Conductive	POX-FREC, POM-EC K	5.3	1.09

Contact area/wear surface of belt will increase from 24% to 47% by the use of inserts.
POX-FREC holds a surface resistivity of 1x10³ Ohm according to IEC 60093/ASTM D257.

Accessories

Flight

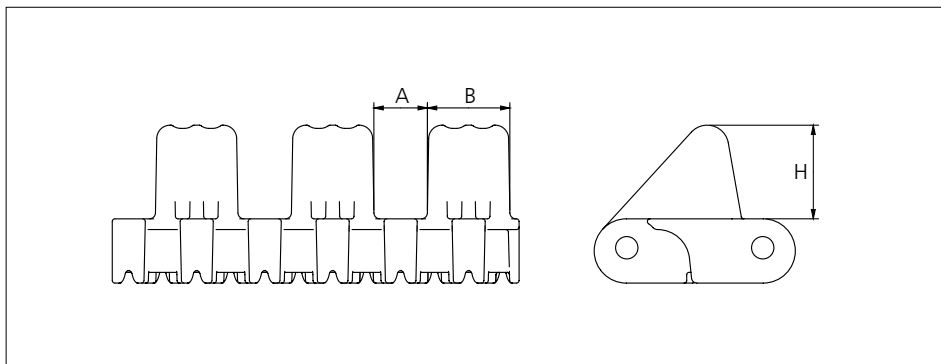

Type	Flight material & color	A		B		H		Link size	Width	
		mm	in	mm	in	mm	in		mm	in
Car Pusher	POM-NL O K POX-FR O EG	20.0	0.79	31.0	1.22	35.0	1.38	K600	152.4	6.00

Backflex radius when flights are used: 200.0 mm (7.87 in).

Accessories

Flight

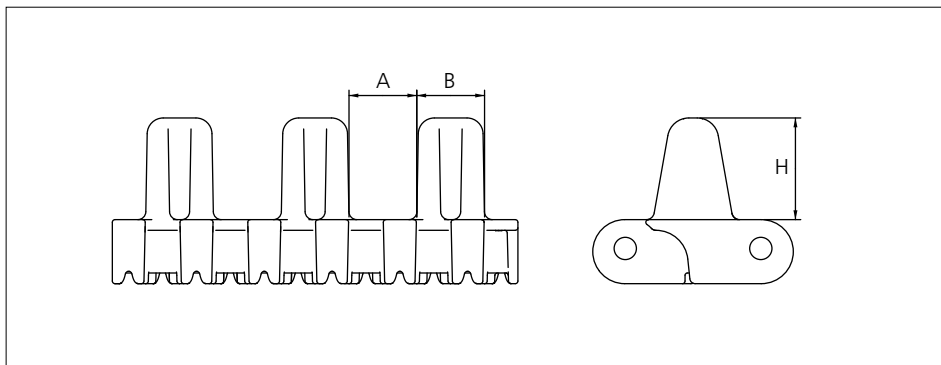

Type	Flight material & color	A		B		H		Link size	Width	
		mm	in	mm	in	mm	in		mm	in
Car Pusher	POM-NL O K POX-FR O EG	25.4	1.00	25.4	1.00	38.1	1.50	K600	152.4	6.00

Backflex radius when flights are used: 200.0 mm (7.87 in).

Accessories

Flight

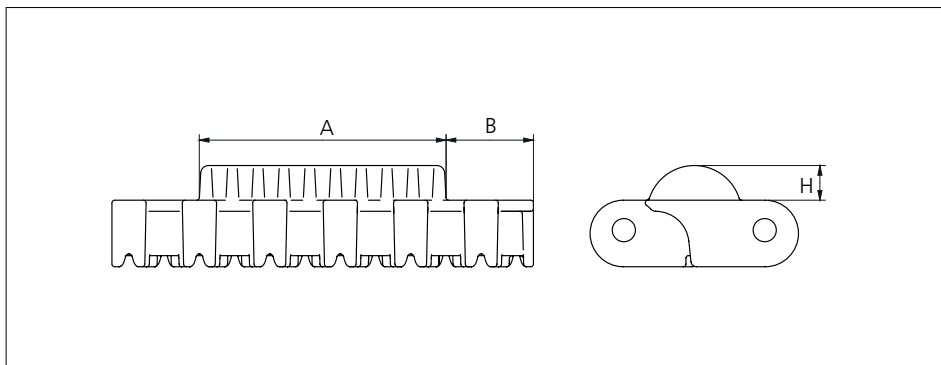

Type	Flight material & color	A		B		H		Link size	Width	
		mm	in	mm	in	mm	in		mm	in
Curved Flight	POM-NL Y	89.0	3.50	31.5	1.24	12.5	0.49	K600	152.4	6.00

Accessories

Side Guard

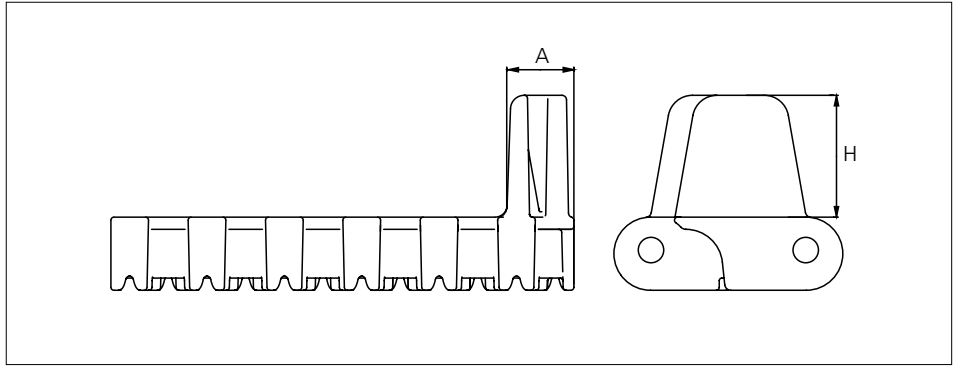

Type	Flight material & color	A		H		Link size	Width	
		mm	in	mm	in		mm	in
Side Guard	POM-NL O K POX-FR O EG	23.0	0.91	40.0	1.57	K600	152.4	6.00

Backflex radius when side guards are used: 115.0 mm (4.53 in).

Sprocket

No of teeth	Bore size							Overall diameter		Pitch-diameter		Hub-diameter		Dimension A*		Dimension B		Double row/One way	Double row/Two way	Molded PA6 LG	Machined PA6
	Pilot bore	in	2.36	2.53	3.03	3.54	4.08														
	mm	60.0	64.0	77.0	90.0	102.0	120.0	mm	in	mm	in	mm	in	mm	in	mm	in				
Z12	✓		■			■		197.3	7.77	197.0	7.76	150.0	5.91	82.0	3.23	109.4	4.31		✓	✓	
Z16	✓		■			■	■	263.0	10.35	261.4	10.29	200.0	7.87	115.0	4.53	141.5	5.57		✓	✓	✓
Z16			■	■		■		263.0	10.35	261.4	10.29	200.0	7.87	115.0	4.53	141.5	5.57	✓		✓	

*A-dimension for automotive applications use A = (B-23.0 mm/0.91 in).

Non standard material and color: See uni Material and Color Overview.

■ Molded sprocket ■ Molded sprocket ■ Machined sprocket

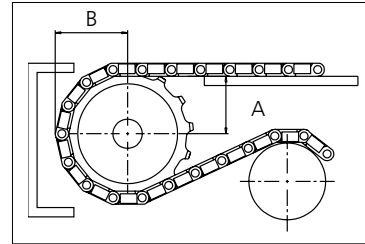
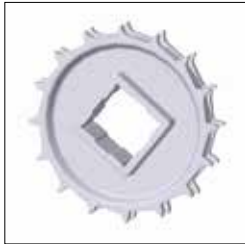

Other sprocket sizes are available upon request.

Two-part sprockets are available upon request.

Round bores are always delivered with keyway.

Other bore sizes are available upon request.

uni Retainer Rings: See uni Retainer Ring data sheet

Width of single tooth = 10.0 mm (0.39 in)

Width of sprocket = 50.0 mm (1.98 in)

Max load per sprocket shown does not take bore size into account.

Please also ensure that sufficient size shaft is chosen for corresponding load.

For correct sprocket position: See uni Assembly Instructions for uni CSB.

For more detailed sprocket information, contact Customer Service.

uni CSB Rough/2022.06.30



Expert advice and quality solutions for all your belting needs.

ammeraalbeltech.com
eptool.online

Ammeraal Beltech Modular A/S

Hjulgagervej 21
DK-7100 Vejle
T +45 7572 3100

ammaega.com

This information is subject to alteration due to continuous development. Ammeraal Beltech will not be held liable for the incorrect use of the above stated information. This information replaces previous information. All activities performed and services rendered by Ammeraal Beltech are subject to general terms and conditions of sale and delivery, as applied by its operating companies.

Member of Ammega Group.